

# **Operator's manual**

# **K2500**

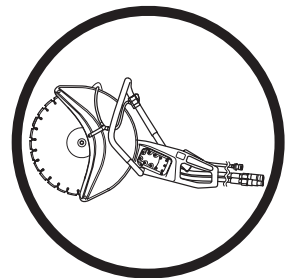

Please read the operator's manual carefully and make sure you understand the instructions before using the machine.

**English**

# KEY TO SYMBOLS

## Key to symbols

WARNING! The machine can be a dangerous tool if used incorrectly or carelessly, which can cause serious or fatal injury to the operator or others.



Please read the operator's manual carefully and make sure you understand the instructions before using the machine.



Always wear:

- Approved protective helmet
- Approved hearing protection
- Protective goggles or a visor
- Breathing mask



This product is in accordance with applicable EC directives.



**Other symbols/decals on the machine refer to special certification requirements for certain markets.**

Always disconnect the machine from the hydraulic hoses before inspection and/or maintenance of the machine.

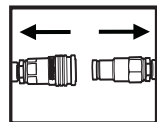

Always wear approved protective gloves.

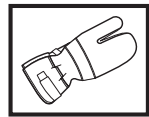

Regular cleaning is required.

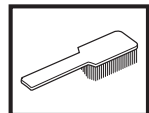

Visual check.



Protective goggles or a visor must be worn.



---

# CONTENTS

---

## Contents

### KEY TO SYMBOLS

Key to symbols ..... 2

### CONTENTS

Contents ..... 3

### WHAT IS WHAT?

What is what on the power cutter? ..... 4

### SAFETY INSTRUCTIONS

Steps before using a new power cutter. .... 5

Personal protective equipment ..... 5

Machine's safety equipment ..... 5

Checking, maintaining and servicing the machine's  
safety equipment ..... 6

General safety precautions ..... 6

General working instructions ..... 7

Cutting blades ..... 9

### ASSEMBLY

Assembly ..... 11

Fitting the cutting blade ..... 11

Guard for the blade ..... 11

### STARTING AND STOPPING

Starting and stopping ..... 12

### MAINTENANCE

Maintenance ..... 13

### TECHNICAL DATA

Technical data ..... 15

Cutting equipment ..... 15

EC-declaration of conformity ..... 15

# WHAT IS WHAT?

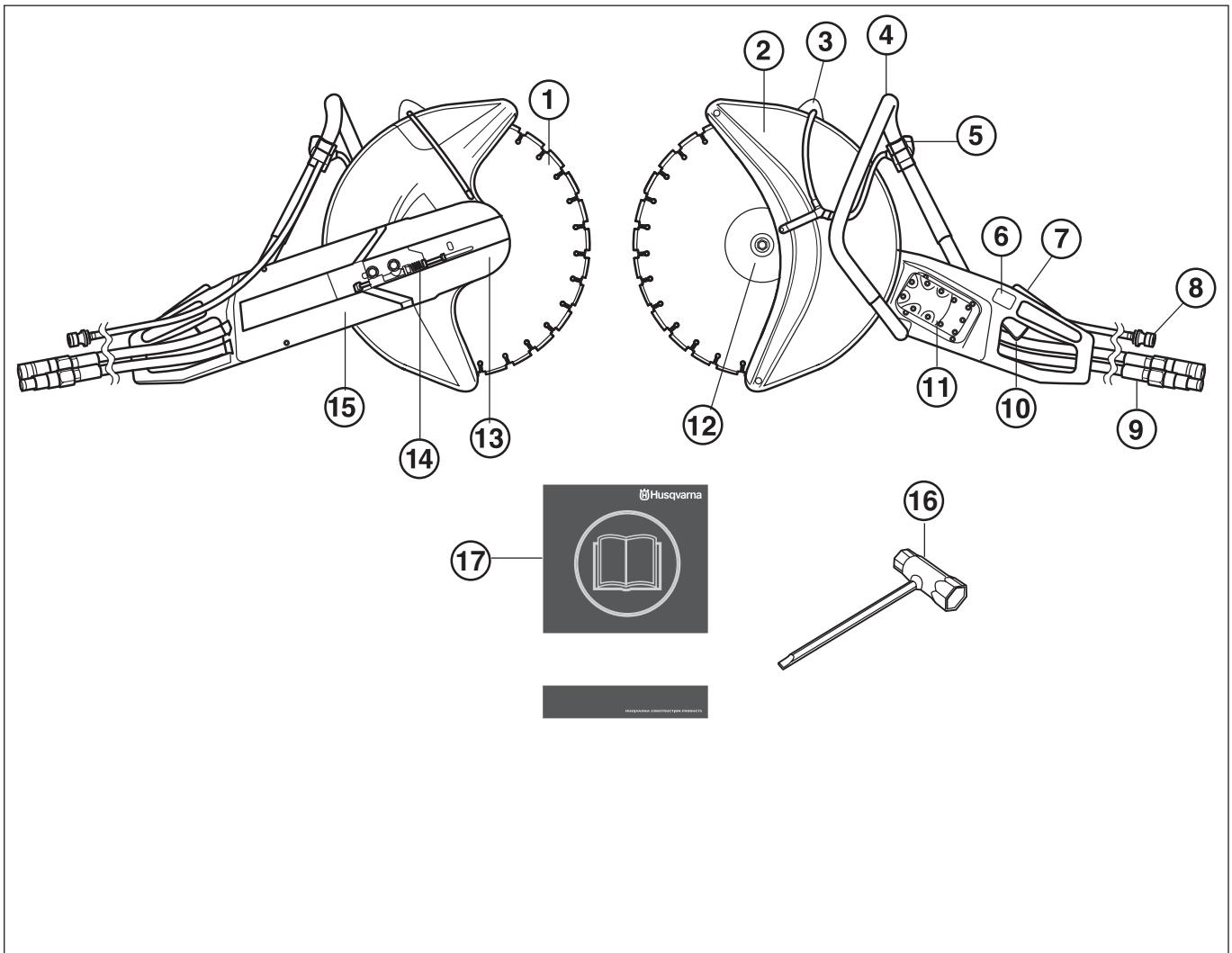

## What is what on the power cutter?

- |                                |                        |
|--------------------------------|------------------------|
| 1 Cutting blade                | 10 Switch              |
| 2 Guard for the blade          | 11 Hydraulic motor     |
| 3 Catch for the guard          | 12 Flange washer       |
| 4 Front handle                 | 13 Belt guard          |
| 5 Water tap                    | 14 Belt tensioner      |
| 6 Rating plate                 | 15 Cutting arm         |
| 7 Switch lock                  | 16 Combination spanner |
| 8 Water connection with filter | 17 Operator's manual   |
| 9 Hydraulic hoses              |                        |

# SAFETY INSTRUCTIONS

## Steps before using a new power cutter.

- This machine is a hydraulically operated power cutter intended for free-hand cutting. The machine should be connected to a hydraulic unit with an oil flow of 35-42 litres/min and a maximum pressure of 150 bar.
- Please read the operator's manual carefully.
- Check the cutting blade's mounting, see the chapter "Assembly".

Let your Husqvarna dealer check the power cutter and make essential adjustments and repairs.



**WARNING!** Under no circumstances may the design of the machine be modified without the permission of the manufacturer. Always use genuine accessories. Non-authorized modifications and/or accessories can result in serious personal injury or the death of the operator or others.



**WARNING!** Use of products which cut, grind, drill, sand or shape material can generate dust and vapors which may contain harmful chemicals. Know the nature of the material being worked on and wear appropriate dust mask or respirator protection.



**WARNING!** A power cutter is a dangerous tool if used carelessly or incorrectly and can cause serious, even fatal injuries. It is extremely important that you read and understand the contents of this Operator's Manual.

Husqvarna Construction Products has a policy of continuous product development. Husqvarna reserves the right to modify the design and appearance of products without prior notice and without further obligation introduce design modifications.

All information and all data in the Operator's Manual were applicable at the time the Operator's Manual was sent to print.

## Personal protective equipment



**WARNING!** You must use approved personal protective equipment whenever you use the machine. Personal protective equipment cannot eliminate the risk of injury but it will reduce the degree of injury if an accident does happen. Ask your dealer for help in choosing the right equipment.

- Protective helmet
- Hearing protection
- Protective goggles or a visor



- Breathing mask

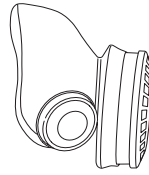

- Heavy-duty, firm grip gloves.

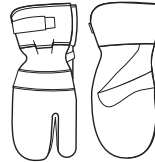

- Tight-fitting, heavy-duty and comfortable clothing that permits full freedom of movement.



- Use leg-guards recommended for the material to be cut.
- Boots with steel toe-caps and non-slip sole



- Always have a first aid kit nearby.



## Machine's safety equipment

This section describes the machine's safety equipment, its purpose, and how checks and maintenance should be carried out to ensure that it operates correctly. See the "What is what?" section to locate where this equipment is positioned on your machine.



**WARNING!** Never use a machine that has faulty safety equipment! Carry out the inspection, maintenance and service routines listed in this section.

## Switch

The switch is used to start and stop the machine.

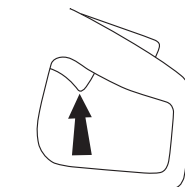

# SAFETY INSTRUCTIONS

## Switch lock

The switch lock is designed to prevent accidental operation of the switch. When the lock (A) is pressed in this releases the switch (B).

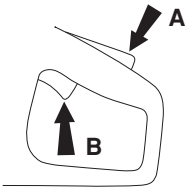

The switch lock remains pressed as long as the switch is pressed. When you release your grip on the handle this resets both the switch and the switch lock. This takes place via two independent return spring systems. This position causes the machine to stop and the switch to be locked.

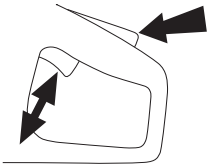

## Guard for the blade

This guard is fitted above the cutting blade and is designed to prevent parts of the blade or cutting fragments from being thrown towards the user.

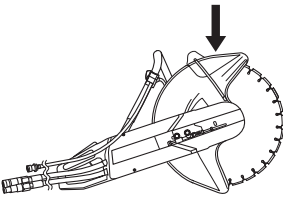

## Checking, maintaining and servicing the machine's safety equipment



**WARNING!** All servicing and repair work on the machine requires special training. This is especially true of the machine's safety equipment. If your machine fails any of the checks described below you must contact your service agent. When you buy any of our products we guarantee the availability of professional repairs and service. If the retailer who sells your machine is not a servicing dealer, ask him for the address of your nearest service agent.

## Checking the starting and stopping functions of the switch

Start the machine, release the switch, and check that the machine and blade stop.

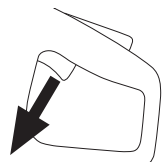

## Checking the switch lock

Check that the switch is locked when the switch lock is in its home position.

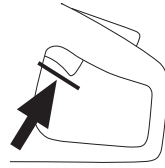

Press the switch lock and check that it returns to its home position when released.

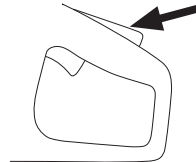

Check that the switch and switch lock move freely and that their return spring systems function.

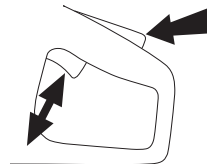

Start the machine, release the switch, and check that the machine and blade stop.

## Checking the blade guard



**WARNING!** Always check that the guard is correctly fitted before starting the machine. Check that the cutting blade is fitted correctly and does not show signs of damage. A damaged cutting blade can cause personal injury. See instructions under the heading Assembly.

Check that the guard is complete and without any cracks or deformations.

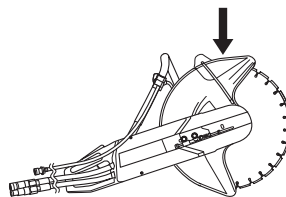

## General safety precautions

- A power cutter is designed to cut hard materials, such as masonry. Observe the increased risk of kickback when cutting soft materials. See instructions under the heading How to avoid kickback.
- Do not use the power cutter until you have read the entire contents of this Operator's Manual. All servicing, in addition to the points listed in the section "Control, maintenance and service of the power cutter's safety equipment", should be carried out by trained service specialists.
- Never use the machine if you are tired, if you have drunk alcohol, or if you are taking medication that could affect your vision, your judgement or your co-ordination.

# SAFETY INSTRUCTIONS

- Wear personal protective equipment. See instructions under the heading Personal protective equipment.
- Never use a machine that has been modified in any way from its original specification.
- Never use a machine that is faulty. Carry out the checks, maintenance and service instructions described in this manual. Some maintenance and service measures must be carried out by trained and qualified specialists. See instructions under the heading Maintenance.
- Never allow anyone else to use the machine without first ensuring that they have understood the contents of the operator's manual.

## Transport and storage

Do not store or transport the power cutter with the cutting blade fitted.

Store the power cutter in a lockable area so that it is out of reach of children and unauthorised persons.

All blades should be removed from the cutter after use and stored carefully. Store cutting blades in dry, frost free conditions.

Special care should be taken with abrasive discs. Abrasive discs must be stored on a flat, level surface. If blades are supplied with a backing pad then a spacer should be used to keep them flat. If an abrasive disc is stored in humid conditions, this can cause imbalance and result in injury.

Inspect new blades for transport or storage damage.

## General working instructions



**WARNING!** This section describes basic safety directions for using a power cutter. This information is never a substitute for professional skills and experience. If you get into a situation where you feel unsafe, stop and seek expert advice. Contact your dealer, service agent or an experienced power cutter user. Do not attempt any task that you feel unsure of!

### Basic safety rules

- Look around you:
  - To ensure that people, animals or other things cannot affect your control of the machine.
  - To make sure that none of the above come into contact with the cutting blade.
- Do not use the machine in bad weather, such as dense fog, rain, strong wind, intense cold, etc. Working in bad weather is tiring and can lead to dangerous conditions, e.g. slippery surfaces.
- Never start to work with the power cutter before the working area is clear and you have a firm foothold. Look out for any obstacles with unexpected movement. Ensure

when cutting that no material can become loose and fall, causing operating injury. Take great care when working on sloping ground.

- Make sure that no clothes or parts of the body come in contact with the cutting equipment when it is rotating.
- Keep at a safe distance from the cutting equipment when it is rotating.
- The guard for the cutting equipment must always be on when the machine is running.
- Ensure that the working area is sufficiently illuminated to create a safe working environment.
- Do not move the machine when the cutting equipment is rotating.
- Always ensure you have a safe and stable working position.
- Make sure that no pipes or electrical cables are routed in the area to be cut.

## Cutting



**WARNING!** The safety distance for the power cutter is 15 metres. You are responsible to ensure that animals and onlookers are not within the working area. Do not start cutting until the working area is clear and you are standing firmly.

### General

- Start cutting with the machine running at maximum speed.
- Always hold the machine in a firm grip with both hands. Hold it so that the thumbs and fingers grip round the handles.

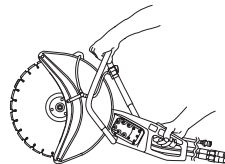

**WARNING!** Overexposure to vibration can lead to circulatory damage or nerve damage in people who have impaired circulation. Contact your doctor if you experience symptoms of overexposure to vibration. These symptoms include numbness, loss of feeling, tingling, pricking, pain, loss of strength, changes in skin colour or condition. These symptoms normally appear in the fingers, hands or wrists.

### Cutting technique

The technique described below is of a general character. Check information for each blade regarding individual cutting characteristics (for example, diamond blades requires less feeding pressure than an abrasive discs).

# SAFETY INSTRUCTIONS

- Support the work piece in such a way that it is possible to predict what will happen, and so that the cut remains open while cutting.

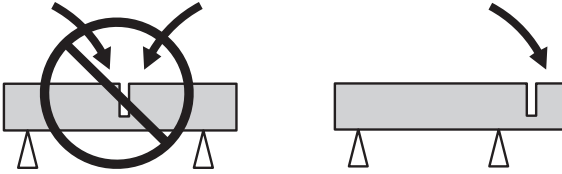

- Check that the blade is not in contact with anything when the machine is started
- Always cut at maximum speed.
- Start cutting smoothly, allowing the machine to work without forcing or pressing in the blade.
- Move the blade slowly forwards and backwards to achieve a small contact area between the blade and the material to be cut. This reduces the temperature of the blade and ensures effective cutting.

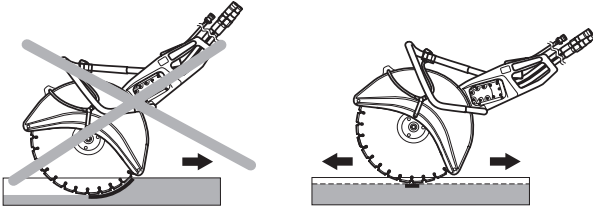

- Feed down the machine in line with the blade. Pressure from the side can damage the blade and is very dangerous.

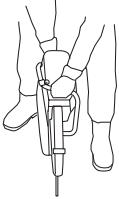

- The guard for the cutting equipment should be adjusted so that the rear section is flush with the work piece. Spatter and sparks from the material being cut are then collected up by the guard and led away from the user.

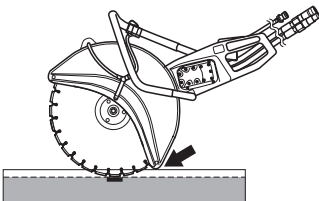

**WARNING!** Under all circumstances avoid grinding using the side of the blade; it will almost certainly be damaged, break and can cause immense damage. Only use the cutting section.

**Do not pull the power cutter to one side, this can cause the blade to jam or break resulting in injury to people.**

## Sharpening diamond blades

Diamond blades can become dull when the wrong feeding pressure is used or when cutting certain materials such as heavily reinforced concrete. Working with a blunt diamond blade causes overheating, which can result in the diamond segments coming loose.

Sharpen the blade by cutting in a soft material such as sandstone or brick.

## Blade vibration

The blade can become out-of-round and vibrate if an excessive feed pressure is used.

A lower feed pressure can stop the vibration. Otherwise replace the blade. The blade must be of the recommended type for the material to be cut.

## How to avoid kickback



**WARNING!** Kickback can happen very suddenly and violently; kicking the power cutter and cutting blade back at the user. If this happens when the cutting blade is moving it can cause very serious, even fatal injuries. It is vital you understand what causes kickback and that you can avoid it by taking care and using the right working technique.

## What is kickback?

The word kickback is used to describe the sudden reaction that causes the power cutter and cutting blade to be thrown from an object when the upper quadrant of the blade, known as the kickback zone, touches an object.

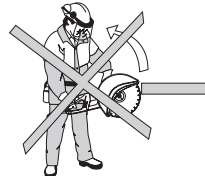

## General rules

- Never start to cut with the upper quadrant of the blade as shown in the figure, also known as the kickback zone.

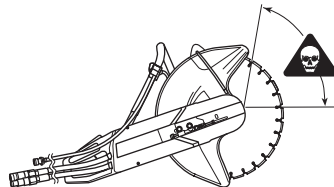

- Always hold the machine in a firm grip with both hands. Hold it so that the thumbs and fingers grip round the handles.

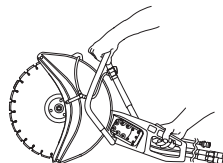

- Keep a good balance and a firm foothold.
- Always cut at maximum speed.



# SAFETY INSTRUCTIONS

- Stand at a comfortable distance from the work piece.
- Take care when inserting the blade in an existing cut.
- Never cut above shoulder height.
- Be alert to movement of the work piece or anything else that can occur, which could cause the cut to close and pinch the blade.

## Pull in

Pull in occurs when the disc's lower section suddenly stops or when the cut closes. (To avoid, see the heading "Basic rules" and "Jamming/rotation", here below.)

## Pinching/rotation

If the cut is pressed together this can lead to jamming. The machine can be pulled down suddenly with a very powerful jerk.

## How to avoid pinching

Support the work piece in such a way that the cut remains open during the cutting operation and when the cut is finished.

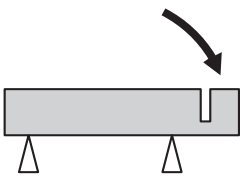

## Cutting blades



**WARNING! A cutting blade may burst and cause injury to the operator.**

**Never use a cutting blade at a lower speed rating than that of the power cutter.**

**Never use a cutting blade for any other materials than that it was intended for.**



**WARNING! Cutting plastics with a diamond blade or rescue blade can cause kickback when the material melts due to the heat produced when cutting and sticks to the blade.**

## General

Cutting blades are available in two basic designs; abrasive discs and diamond blades.

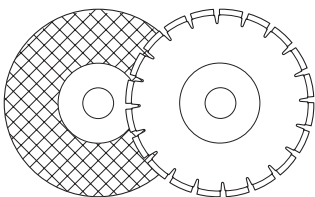

Always remove the cutting blade when the machine is transported.

Make sure that the right bushing is used for the cutting blade to be fitted on the machine. See the instructions under the heading Assembling the cutting blade.

High-quality blades are often most economical. Lower quality blades often have inferior cutting capacity and a shorter service life, which results in a higher cost in relation to the quantity of material that is cut.

## Water cooling



**WARNING! Water cooling, which is used when cutting concrete, cools the blade and increases its service life while also reducing the formation of dust. Disadvantages include difficulties at very low temperatures, the risk of damaging floors and other structural elements, and the risk of slipping.**

After using an abrasive disc with water cooling, run the disc dry for about half a minute. If an abrasive disc is stored in humid conditions, this can cause imbalance and result in injury.

## Hand-held, high-speed machines

Our cutting blades are manufactured for high-speed, portable power cutters. If blades from other manufacturers are used, ensure that the blades conform to all regulations and demands that concern this type of power cutter.

## Special blades

Some cutting blades are designed for stationary equipment and for use with attachments. Such cutting blades must not be used on portable power cutters.

Always contact local authorities and make sure you are following applicable directives.

## Abrasive discs

The cutting material on abrasive discs consists of grit bonded using an organic binder. "Reinforced blades" are made up of a fabric or fibre base that prevents total breakage at maximum working speed if the blade should be cracked or damaged.

A cutting blade's performance is determined by the type and size of abrasive corn, and the type and hardness of the bonding agent.

Abrasive discs, types and use		
	Use	
Disc type	Material	Water cooling
Concrete	Concrete, asphalt, stone masonry, cast iron, aluminium, copper, brass, cables, rubber, plastic, etc.	Can be used to reduce dust. Run the disc dry for about a half minute after using an abrasive disc with water cooling.
Metal	Steel, steel alloys and other hard metals.	NOT recommended

# SAFETY INSTRUCTIONS

Check that the blade is approved for the same or higher speed according to the approval plate of the engine. Never use a cutting blade with a lower speed rating than that of the power cutter.

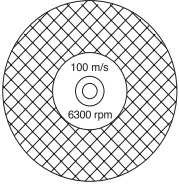

Ensure the blade is not cracked or damaged in any other way.

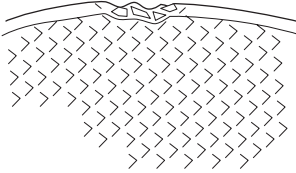

Test the abrasive disc by hanging it on your finger and tapping it lightly with a screwdriver or the like. If the disc does not produce a resonant, ringing sound it is damaged.

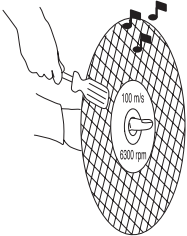

## Diamond blades

Diamond blades consist of a steel body provided with segments that contain industrial diamonds.

Diamond blades ensure lower costs per cutting operation, fewer blade changes and a constant cutting depth.

When using diamond blades make sure that it rotates in the direction indicated by the arrow on the blade.

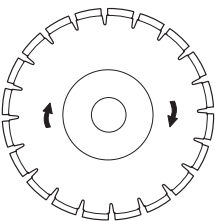

Always use a sharp diamond blade. Sharpen the blade by cutting in a soft material such as sandstone or brick.

Diamond blades are available in several hardness classes. A "soft" diamond blade has a relatively short service life and large cutting capacity. It is used for hard materials such as granite and hard concrete. A "hard" diamond blade has a longer service life and reduced cutting capacity, and should be used for soft materials such as brick and asphalt.

## Material

Diamond blades are ideal for masonry, reinforced concrete and other composite materials. Diamond blades are not recommended for cutting metal.

## Diamond blades for wet cutting



**WARNING!** Cool diamond blades for wet cutting continuously with water to prevent overheating, which can cause the blade to break up and eject pieces that can cause injury.

Diamond blades for wet cutting should have water poured over them during the cutting to cool the blade and bond the dust.

## Diamond blades for dry cutting

Diamond blades for dry cutting are a new generation of blades that do not require water cooling. However, the blades will still be damaged by excessive heat. It is most economical to allow the blade to cool by simply lifting it out from the cut every 30–60 seconds and letting it rotate in the air for 10 seconds.

# ASSEMBLY

## Assembly

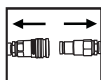

**WARNING! Always disconnect the machine from the hydraulic hoses before cleaning, assembly and maintenance.**

## Fitting the cutting blade

Husqvarna's blades are approved for hand-held power cutters. Blades are manufactured with three different diameters of centre holes: 20 mm (0.787"), 22.2 mm (7/8") and 25.4 mm (1"). Bushings can be fitted on the machine axle to adjust the machine to the centre hole of the blade. Use a bushing with the correct diameter! The blades are marked with the diameter of the centre hole.

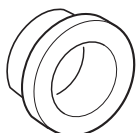

The blade is placed on the bushing (C) between the inner flange washer (A) and the flange washer (B). The flange washer is turned so that it fits on the axle.

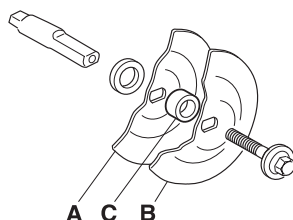
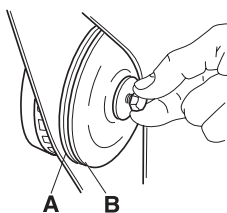

Tightening torque for the bolt holding the blade is: 15-25 Nm (130-215 in.lb).

The axle can be locked by inserting a screwdriver or the like in the hole in the belt guard.

When a diamond blade is mounted on the power cutter make sure that the diamond blade will rotate in the direction indicated by the arrow on the blade.

When the blade is replaced with a new one, check the flange washers and the drive axle. See instructions under the heading Checking the drive axle and flange washers.

## Checking the drive axle and flange washers



Check that the threads on the drive shaft are undamaged.

Check that the contact surfaces on the blade and the flange washers are undamaged, of the correct dimension, clean, and that they run properly on the drive axle.

Do not use warped, notched, indented or dirty flange washers. Do not use different dimensions of flange washers.

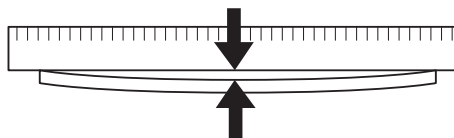

## Cutting arm

It is possible to turn the cutting arm 180° so that the blade comes on the other side of the cutting arm. This simplifies cutting close to obstacles such as walls and floors etc. The cutting arm and drive belt are released in the same way as when replacing the drive belt. See instructions under the heading Replacing the drive belt.

Turn the arm 180°, replace the respective parts, and screw them secure in the same way as before.

If you are using a diamond blade you must also turn it so that it rotates in the right direction. A diamond blade must rotate in the direction shown by the arrow marking on the blade.

## Guard for the blade

The guard must always be fitted on the machine.

The guard for the cutting equipment should be adjusted so that the rear section is flush with the work piece. Spatter and sparks from the material being cut are then collected up by the guard and led away from the user.

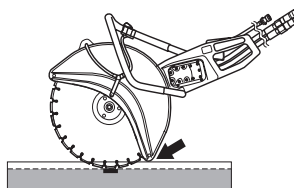

# STARTING AND STOPPING

## Starting and stopping



**WARNING!** Note the following before starting:

**Make sure you have a secure footing and that the cutting blade cannot touch anything.**

**Keep people and animals well away from the working area.**

### Starting

- Grip the front handle with the left hand.

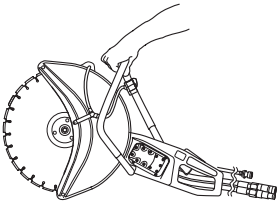

- Grip the rear handle with the right hand. When you grip the rear handle this releases the switch lock.

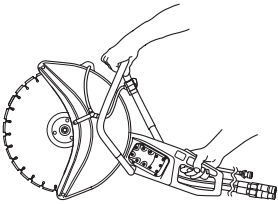

### Stopping

The machine is stopped by releasing the switch.

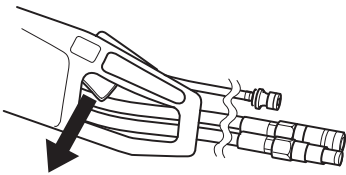

# MAINTENANCE

## Maintenance

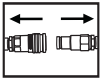

**WARNING! Inspection and/or maintenance should be carried out with the hydraulic hoses disconnected.**

### Tensioning the drive belt

The drive belt is fully enclosed and well protected from dust and dirt.

When the drive belt is to be tensioned, release the nuts holding the cutting arm.

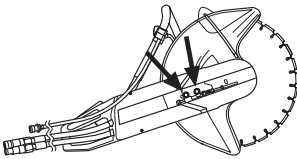

Screw the adjuster screw so that the square headed nut comes opposite the marking on the cover. This automatically ensures that the belt has the correct tension.

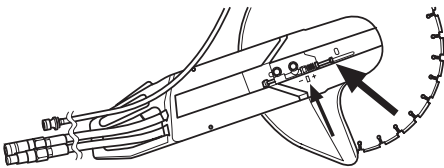

Tighten the two nuts holding the cutting arm.

### Replacing the drive belt

First release the nuts and then the adjuster screw to release the belt tension.

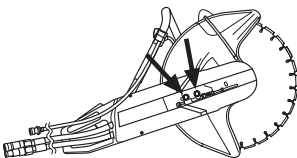

Unscrew the nuts and lift off the front belt guard.

The cutting head is now loose and can be removed from the machine. Remove the rear belt guard by releasing the two screws holding the guard.

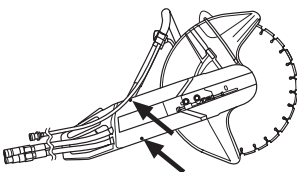

Take off the old belt and fit the new one. Fit the cutting arm to the machine and tension the belt with the adjuster screw. A new drive belt should be re-tensioned after running for about 30 minutes.

### Checking the drive axle and flange washers

Check that the threads on the drive shaft are undamaged. Check that the contact surfaces on the blade and the flange washers are undamaged, of the correct dimension, clean, and that they run properly on the drive axle.

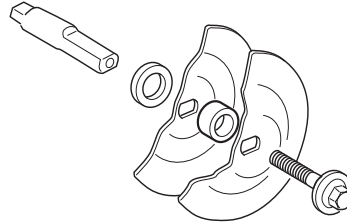

Do not use warped, notched, indented or dirty flange washers. Do not use different dimensions of flange washers.

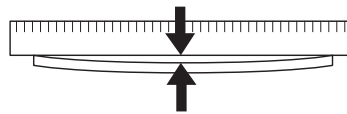

### Water cooling

Check that the water tap functions. To open the water tap, turn the tap to open position.

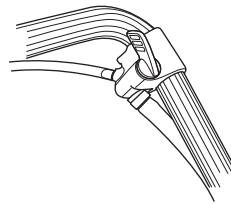

To turn off the water, turn the tap to closed position.

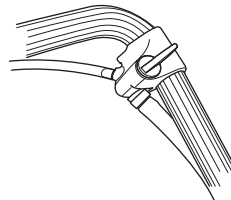

### Water filter

Check and clean the filter if necessary.

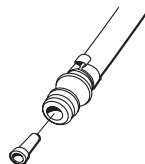

---

# MAINTENANCE

---

## Daily maintenance

Carry out the following checks daily before using the machine.

- 1 Check that nuts and screws are tight.
- 2 Check that the power source (the hydraulic unit) supplies the correct oil flow and oil pressure.
- 3 Check that the hydraulic hoses and couplings are clean and undamaged.
- 4 Connect the machine hoses with the hoses from the power source.
- 5 Start the power source and check that the power cutter functions by starting the machine with the switch in the rear handle. Check that the blade stops when the switch is released.
- 6 Checking the blade guard
- 7 Check the condition of the cutting blade.
- 8 Check the tension of the drive belt.



---

# TECHNICAL DATA

---

## Technical data

<b>Technical data</b>	<b>K2500</b>
<b>Engine</b>	
Hydraulic oil flow, l/min / gpm	35-42 / 9-11
Working pressure, bar / psi	130-140 / 2000
Max. working pressure, bar / psi	150 / 2200
Max. speed of output shaft, rpm	4300
Drive system, V-belt	SPZ
<b>Weight</b>	
Power cutter without cutting blade, kg	8,3
<b>Sound levels</b>	
Noise pressure level at the operators ear, max. speed, measured according to ISO/DIS 15744, ISO/DIS 11201, dB (A)	85
<b>Noise emissions</b>	
Sound power level, measured dB(A)	106
Sound power level, guaranteed L <sub>WA</sub> dB(A)	107
<b>Vibration levels</b>	
(see note 1)	
Front handle, m/s <sup>2</sup>	7,5
Rear handle, m/s <sup>2</sup>	5,2

Note 1: Handle vibrations are measured according to ISO 8662-4

## Cutting equipment

Cutting blade	Max. peripheral speed, m/s
16"	100

## EC-declaration of conformity

### (Applies to Europe only)

**Husqvarna Construction Products**, SE-433 81 Partille, Sweden, tel: +46-31-949000, declares under sole responsibility that the power cutter **K2500** from year 2006 serial numbers and onward (the year is clearly stated in plain text on the rating plate with subsequent serial number) conforms with the requirements of the COUNCIL'S DIRECTIVE:

- of June 22, 1998 "relating to machinery" **98/37/EC**, annex IIA.

The following standards have been applied: **EN ISO 12100:2003, EN 982:1996, EN 792-7:2001**

SMP Svensk Maskinprovning AB, Fyrisborgsgatan 3, SE-754 50 Uppsala, Sweden, has performed voluntary type examination on behalf of Husqvarna AB. The certificates are numbered: **01/169/009** – K2500.

Partille November 14, 2006



Ove Donnerdal, Development Manager

1150293-26



2006-12-20